

# iHome2GO™ cyclers™

Model iH85  
**Bicycle Speaker System**  
**For Your iPod®**

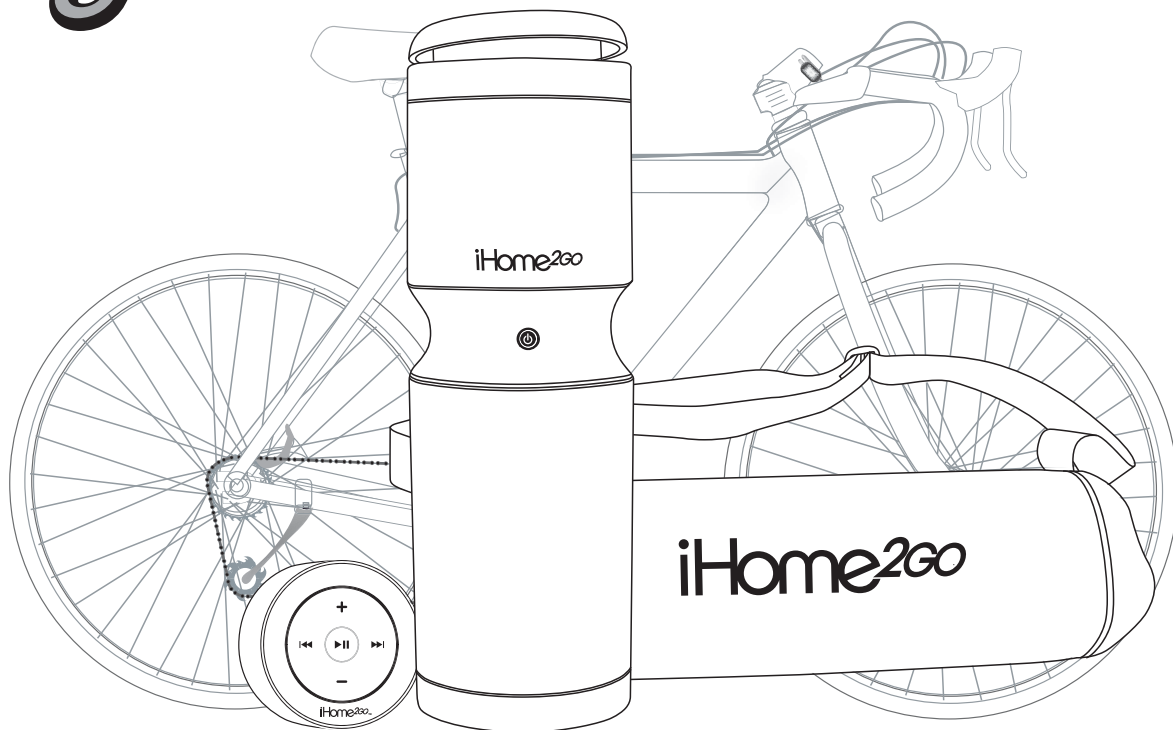

**Questions? Visit [www.ihomeaudio.com](http://www.ihomeaudio.com)**

## Table of Contents

A Consumer Guide to Product Safety .....	1
Quick Start .....	2
Attaching the Remote and Mounting Bracket .....	3
Controls and Indicators .....	4
Using the iH85 .....	5,6
Charging your iPod .....	6
Listening to iPod .....	6
Batteries Installation .....	6
A Consumer Guide to Product Safety .....	7
Trouble Shooting .....	8
Solución De Problemas .....	9
Warranty Information .....	10

## Package Contents

Congratulations on your iH85 Cyclor bicycle speaker system for the iPod. Before you set up your unit, please check to see that the package contains the following items:

- 1 Main Unit
- 1 AC Adaptor
- 1 Mounting bracket
- 2 Hex head mounting screws
- 1 Remote control with mounting clamp and 2 CR2032 batteries (installed)
- 3 iPod inserts
- 1 Audio patch cord
- 1 Carry bag

### Maintenance

- Place the unit on a level surface away from sources of direct sunlight or excessive heat.
- Protect your furniture when placing your unit on a natural wood and lacquered finish. A cloth or other protective material should be placed between it and the furniture.
- Clean your unit with a soft cloth moistened only with mild soap and water. Stronger cleaning agents, such as Benzine, thinner or similar materials can damage the surface of the unit.

## A Consumer Guide to Product Safety

**IMPORTANT SAFETY INFORMATION: IT IS THE USER'S RESPONSIBILITY TO USE THIS PRODUCT PRUDENTLY, RESPONSIBLY AND IN A SAFE, NON-DISTRACTED MANNER AT ALL TIMES. FAILURE BY THE USER TO PAY FULL ATTENTION TO THE PROPER OPERATION OF ANY EQUIPMENT BEING USED ALONG WITH THIS PRODUCT COULD RESULT IN AN ACCIDENT AND/OR PERSONAL INJURY.**

This device complies with Part 15 of the FCC Rules. Operation is subject to the following two conditions: (1) this device may not cause harmful interference, and (2) this device must accept any interference received, including interference that may cause undesired operation.

**Warning:** Changes or modifications to this unit not expressly approved by the party responsible for compliance could void the user's authority to operate the equipment.

**NOTE:** This equipment has been tested and found to comply with the limits for a Class B digital device, pursuant to Part 15 of the FCC Rules. These limits are designed to provide reasonable protection against harmful interference in a residential installation. This equipment generates, uses and can radiate radio frequency energy and, if not installed and used in accordance with the instructions, may cause harmful interference to radio communications.

However, there is no guarantee that interference will not occur in a particular installation. If this equipment does cause harmful interference to radio or television reception, which can be determined by turning the equipment off and on, the user is encouraged to try to correct the interference by one or more of the following measures:

- Reorient or relocate the receiving antenna.

- Increase the separation between the equipment and receiver.

- Connect the equipment into an outlet on a circuit different from that to which the receiver is needed.

- Consult the dealer or an experienced radio/TV technician for help.

Shielded cables must be used with this unit to ensure compliance with the Class B FCC limits.

# iH85 Quick Start

## 1: Opening and Closing

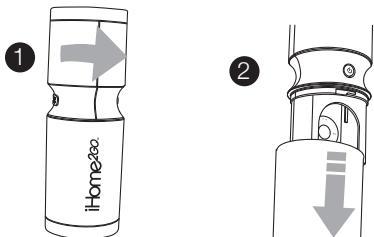

1. Twist the top half of the case as shown
2. Lift off.

When the case is open, you can change batteries and access (dock and undock) your iPod.

To close the case, place case halves together and twist until arrows align.

## 2: Power: AC or Batteries

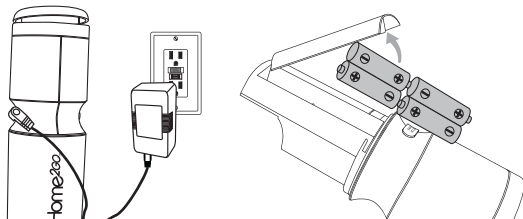

To charge and play iPod, attach AC adaptor to jack at waist of the iH85 (under rubber tab) and plug the other end into a working AC outlet. Does not charge batteries. For portable operation (on bike, etc.), open the battery door located inside the unit behind the iPod dock. Install 4 AA batteries (match + and - polarity in diagram).

Your iH85 comes with 3 inserts to ensure your iPod fits properly in the dock. Note: Thick iPod models dock without insert

Mini Insert	Thin iPod Insert	Thick iPod (no insert needed)	Nano Insert
Use with iPod Mini	iPod 4G 20 GB iPod Photo 20/30 GB 5G iPod w/ Video 30 GB	iPod 4G 40 GB iPod Photo 60 GB 5G iPod w/ Video 60/80 GB	iPod Nano 2/4/8 GB

## 3: Docking a Thin iPod

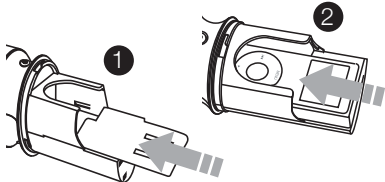

1. Gently slide the Thin iPod insert into the dock.
2. Carefully place your iPod onto the dock connector. The iPod must not be in a case or "skin".

## 4: Docking a Nano or iPod Mini

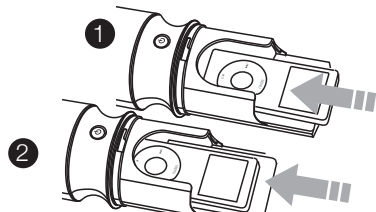

1. Gently guide the nano or mini onto the connector pins in the dock
2. Slide the nano insert over the docked nano OR the mini insert over the docked mini

## 5: Playing iPod

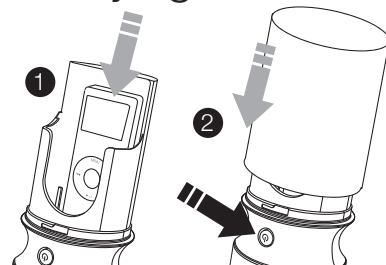

Insert iPod into dock with proper insert as needed. When running on AC power, the iPod will charge while docked. Press the Power Button on the iH85 to play iPod.

## Attaching the Remote Clamp and Mounting Bracket

### 1: Mounting Remote Clamp To Handlebars

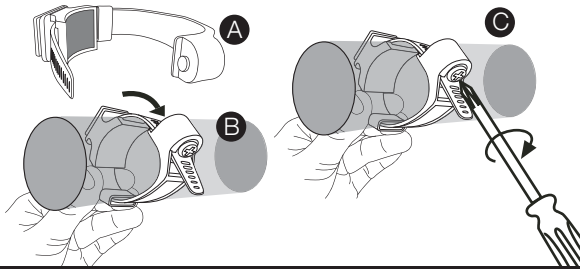

- a) Using Phillips screw driver, open mounting clamp.
- b) Wrap mounting clamp around handle bar. The square top should face the bicycle seat
- d) Tighten clamp using a Phillips screwdriver

### 2: Attach Remote To Clamp

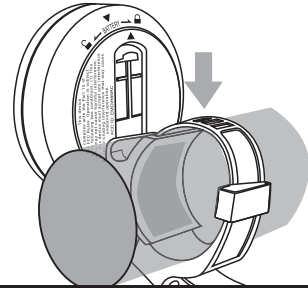

To attach the iH85 remote, slide the mounting slot on back of the remote down the square top of the clamp until it clicks. Press clip button to release. Do not leave remote on bike when unattended.

### 3: Mounting Bracket

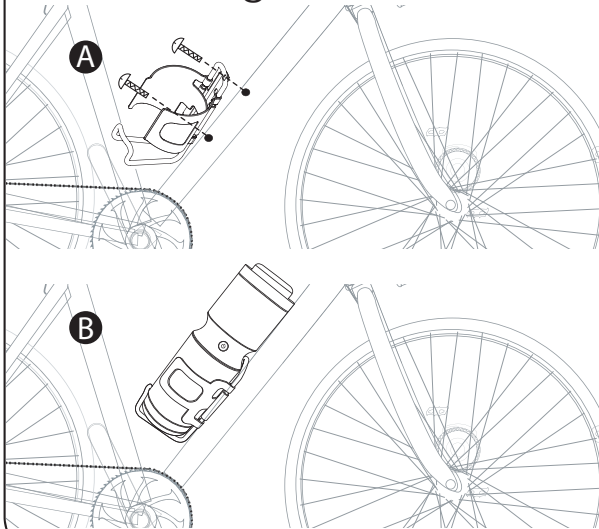

#### Attaching the Mounting Bracket

- a) Align bracket with existing bottle bracket holes on down tube
- b) Screw bracket firmly to down tube with hex (Allen) wrench until securely fastened

To attach the iH85, slide it into the bracket with the Power button facing you and the speaker facing up.

## Remote Panel

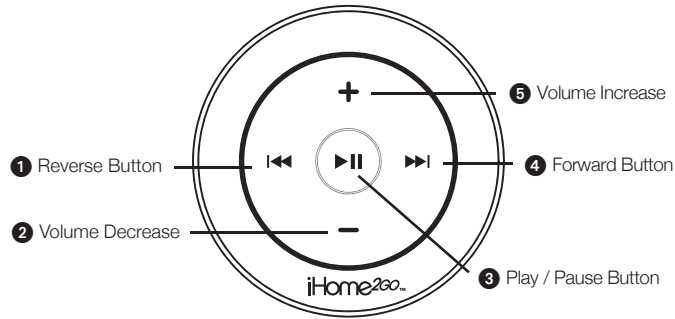

## Front Panel

Remote for easy storage

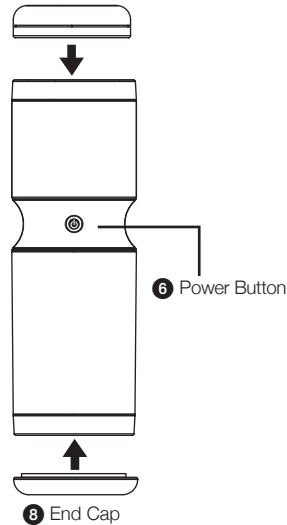

## Back Panel

Remote for easy storage

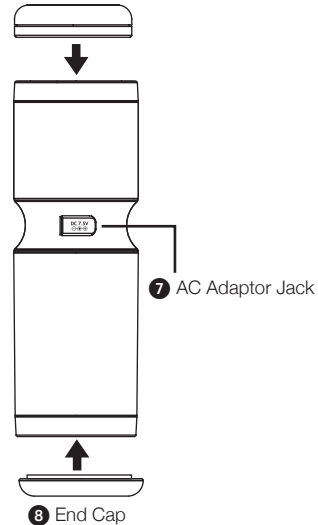

During use, place the end cap on the bottom of the iH85. When not in use, place the end cap on top to protect the speaker.

## Using the iH85

### Connecting iH85 to AC Power Source

Plug the AC adaptor cable into the ⑦ AC Adaptor Jack located at the waist of the unit (under the rubber tab) and the other end into a standard 120 VAC wall socket. If an iPod is properly connected, it will begin charging, indicated by a flashing LED. The iH85 also operates on 4 “AA” batteries (see page 4 for information on installing/replacing batteries) for portable playing. The AC adaptor charges the iPod with or without batteries installed. The unit will not charge your iPod while operating just on batteries.

**NOTE:** To save battery life, when running on batteries unit will automatically power OFF after 2 hours of non-use (no button activation). Press any button to re-activate the unit.

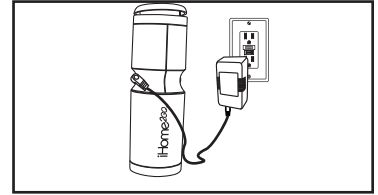

### Install/Replace Batteries

The iH85 uses 4 “AA” batteries for portable playing. The iH85 will not charge your iPod while operating on batteries.

If sound becomes weak or distorted, replace the batteries.

- Unscrew outer case and remove
- Open the battery compartment cover located inside unit above the AC adaptor jack.
- Insert 4 “AA” batteries as indicated
- We recommend the use of alkaline batteries for longer life

**NOTE: AC adaptor does not charge batteries**

Batteries information:

- Do not mix old and new batteries.
- Do not mix alkaline, standard (carbon -zinc) or rechargeable (nickel-cadmium) batteries.

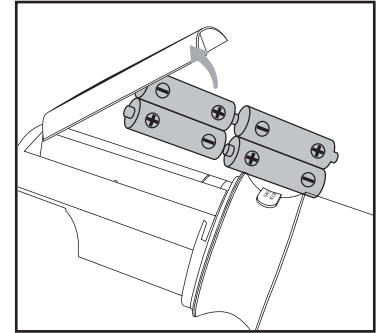

### To check for iPod compatibility

iH85 is an advanced system and supports most updated iPod features. To have your iPod working properly with the iH85, please update your iPod firmware with the latest one. Please check Apple website for the latest firmware.

### Docking iPod and Inserts

Your iH85 comes with 3 inserts (nano, mini and thin) to ensure your iPod fits properly on the dock located inside the case. Thick iPod models do not require inserts. The iPod must not be in a case or “skin”.

### To dock a thin iPod model

1. Gently slide the thin iPod insert into the dock
2. Carefully place your iPod within insert onto connector in the dock

### To dock a nano or mini iPod model

1. Gently slide the nano or mini iPod onto the connector pin in the dock.
2. Carefully slide the nano insert over the docked nano or the mini insert over the docked mini

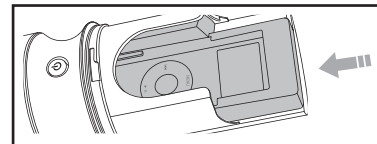

## Charging your iPod

**NOTE:** Please make sure your iPod is docked correctly using the correct insert (see above) . Failure to do so may damage your iPod.

1. While your iPod is docked in the unit and the unit is connected to AC power, it charges the iPod (until fully charged). iPod will not be charged when using battery power.
2. The LED indicator will flash to show the iPod is charging. During iPod play, the LED stays on.

## Listening to iPod

1. If you dock an already-playing iPod, the iH85 will automatically turn on and you will hear music playing from your iPod.  
**NOTE:** If the loudness of the music is too low on the iPod itself, iH85 may not detect the iPod is in play mode. Press the **6** Power Button to play it.
2. When the iPod is docked and in standby mode, press the Power On/Off Button on the iH85 to play it. The LED indicator will stay on to show the power is on.
3. Press the **3** Play/Pause Button on the remote control to pause play; press again to resume it.
4. Press the **5** Volume + and **2** Volume – Button on the remote control to adjust the system volume.
5. Press **4** >> or **1** << Button on remote control to go to the next or previous track. Press and hold while track is playing for high speed forward or reverse music search of the current track.
6. To turn off the iH85, press the **6** Power on/off Button. If the unit is connected to AC outlet, your iPod will continue charging while in the dock. You cannot power off the unit using the remote control.

## Batteries Installation

### Install/Replace the Remote Control Batteries

The remote control batteries are already installed at the factory. When the remote control stops operating or its range seems reduced, replace the batteries with new ones.

1. The battery compartment cover is located on the bottom of the remote control.
2. Use a Phillips screwdriver to unscrew the retaining screw on the battery compartment cover.
3. Turn the battery compartment cover counterclockwise slightly to unlock the battery cover. Remove the cover.
4. Insert 2 CR2032 batteries, checking the + and – sides of the batteries match the diagram inside the battery compartment.
5. Replace the battery cover, turn clockwise to lock and replace the retaining screw.

**NOTE:** Make sure you dispose of batteries properly (see your local regulations).

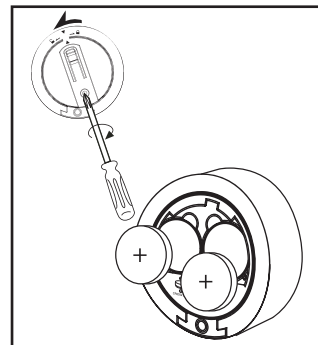



# IMPORTANT SAFETY INSTRUCTIONS

When used in the directed manner, this unit has been designed and manufactured to assure your personal safety. However, improper use can result in potential electrical shock or fire hazards. Please read all safety and operating instructions carefully before installation and use. Keep these instructions handy for future reference. Take special note, and adhere to all warnings on the unit and in the instruction and service manual.

1. **Water and Moisture** - The unit should not be used near water. For example, near a bathtub, washbowl, kitchen sink, laundry tub, in a wet basement, or near a swimming pool, etc., when using the AC adaptor.
2. **Ventilation** - The unit should be situated so that its location or position does not interfere with its proper ventilation. For example, it should not be situated on a bed, sofa, rug, or similar surface that may block the ventilation openings; or placed in a built-in installation, such as bookcase or cabinet that may impede the flow of air through the ventilation openings.
3. **Heat** - The unit should be situated away from heat source such as radiators, heat register, stoves, or other appliances (including amplifiers) that produce heat.
4. **Power Sources** - The unit should be connected to a power supply only of the type described in the operating instructions or as marked on the appliance.
5. **Power Cord Protection** - Power supply cord should be routed so that they are not likely to be walked on or pinched by items placed upon or against them. It is always best to have a clear area from where the cord exits the unit to where it is plugged into an AC outlet.
6. **Cleaning** - The unit should be cleaned only as recommended by the manufacturer.
7. **Object and Liquid Entry** - Care should be taken so that objects do not fall and liquids are not spilled into the enclosure through openings.
8. **Attachments** - Do not use attachments not recommended by the product manufacturer.
9. **Lightning and Power Surge Protection** - Unplug the unit from the wall outlet and disconnect the antenna or cable system during a lightning storm or when it is left unattended and unused for long periods of time. This will prevent damage to the product due to lightning and power-line surges.
10. **Overloading** - Do not overload wall outlets, extension cords, or integral convenience receptacles as this can result in a risk of fire or electric shock.
11. **Damage Requiring Service** - The appliance should be serviced by qualified service personnel when:
  - A. The power-supply cord or plug has been damaged.
  - B. Objects have fallen into or liquid has been spilled into the enclosure.
  - C. The unit has been exposed to rain.
  - D. The unit has been dropped or the enclosure damaged.
  - E. The unit exhibits a marked change in performance or does not operate normally.
12. **Periods of Nonuse** - If the unit is to be left unused for an extended period of time, such as a month or longer, the power cord should be unplugged and take out batteries from the unit to prevent damage or corrosion.
13. **Servicing** - The user should not attempt to service the unit beyond that described in the user's operating instructions. All other servicing should be referred to qualified service personnel.

**Questions? Visit [www.ihomeaudio.com](http://www.ihomeaudio.com)**

## Trouble Shooting

Symptom	Possible Problem	Solution
Unit doesn't respond (no power)	AC adaptor isn't plugged to a wall outlet or the connector is not plugged into the power supply jack on the back of the unit. Plug the AC adaptor into a wall outlet and plug the connector into the AC jack on the unit	Plug the AC adaptor into a wall outlet and plug the connector into the AC jack on the unit
	Wall outlet is not functioning	Plug another device into a wall outlet (same outlet) to confirm the outlet is working
	Batteries are weak or dead on unit or remote	Replace all the batteries with new ones
	Power is off	Press the Power button on the iH85
iPod does not dock properly	Using no or wrong iPod insert	Make sure the dock insert is the proper fit to your iPod
	iPod is not installed properly	Remove your iPod from the dock and check for obstruction on the connectors in the dock and on your iPod. Then reseat it in the dock.
iPod does not respond to the unit	iPod is not installed properly	Remove your iPod from the dock and check for obstruction on the connectors in the dock and on your iPod. Then reseat it in the dock.
	Your iPod software is too old	Upgrade software on your iPod. For details, visit <a href="http://www.apple.com/ipod/download">http://www.apple.com/ipod/download</a>
	iPod is locked up/frozen	Please make sure your iPod is working properly before dock into the unit. Please refer to your iPod manual for detail.
iPod didn't charge up	Unit is not plugged into a working AC outlet	Make sure unit is plugged into working outlet and all connections are good
	iPod is not installed properly	Remove your iPod from the dock and check for obstruction on the connectors in the dock and on your iPod. Then reseat it in the dock.
	Using 3rd generation iPod	iH85 does not support 3rd generation iPod
	iPod is locked up/frozen	Please make sure your iPod is working properly before docking in the unit. Please refer to your iPod manual for detail.
	iPod battery has problem	Please refer to your iPod manual for detail.
Sound is distorted	Volume level is set too high	Decrease the volume
	Sound source is distorted	If iPod original sound source is poor quality, distortion and noise are easily noticed with high-power speakers.
		Try turning bass boost OFF
		Make sure end cap or remote is not covering speaker during use
Remote Control didn't work	Batteries are weak/ dead	Replace with new batteries
	Remote Control is too far way from main unit	Move the Remote Control closer to main unit

**NOTE: When AC adaptor is plugged in, your iPod will charge (with or without batteries installed).**

**NOTE: Unit does not control or charge 3G iPod**

## Solución De Problemas

Síntoma	Posible Problema	Solución
La Unidad no responde (no hay poder)	El adaptador de corriente alterna no está conectado a la unidad o no enchufado al la espalda de la unidad. Tape el adaptador CA a un outlet de pared y tape el conector en el gato de corriente alterna del unidad.	Enchufe el adaptador de corriente alterna al toma corriente y enchufe el conector al gato de corriente alterna en la unidad.
	Tomacorriente no funciona	Enchufe otro aparato(mismo outlet) para segura que hay corriente.
	Los pilas son debil o muerto en la unidad o el remoto.	Reemplace todas Pilas con nuevos.
	El poder está apagado	Apriete el botón del poder en el IH85
iPod no atracar apropiadamente	No está utilizando las adiciones correctos o sin ningun metes.	cerciórese la adición de dársena es el ataque apropiado a su iPod
	iPod no es instalado apropiadamente	Quite su ipod de la dársena y el cheque para el obstuccion en los conectores en la dársena y en su ipod. Entonces acomodarlos en la dársena.
iPod no responde a la unidad.	iPod no es instalado apropiadamente	Quite su ipod de la dársena y el cheque para el obstuccion en los conectores en la dársena y en su ipod. Entonces acomodarlos en la dársena.
	Su software de Ipod es demasiado viejo.	mejore software en su ipod para detalles visita ; <a href="http://www.apple.com/ipod/download">http://www.apple.com/ipod/download</a>
	iPod es cerrado/congelado	Cerciórese por favor su Ipod trabaja apropiadamente antes de dársena en la unidad. Para más detalles, consulte el manual de su iPod.
iPod no cargó arriba	La unidad no es tapada en un outlet de trabajo de C.A.	Cerciórese la unidad está enchufada en un tomacorriente que trabaja y todas conexiones son buenas..
	iPod no es instalado apropiadamente	Quite su ipod de la dársena y el cheque para el obstuccion en los conectores en la dársena y en su iPod. Entonces acomodarlos en la dársena.
	Utilizando iPod tercero de generación	ipod no sostiene la generación tercera
	iPod es cerrado/congelado (iPOD is locked or frozen) La batería de iPOD tiene el problema )	Cerciórese por favor su Ipod trabaja apropiadamente antes de dársena en la unidad. Para más detalles, consulte el manual de su iPod.
El sonido es retorcido	el nivel puesto del volumen es muy alto.	bajar de volumen.
	La fuente sano es retorcida	Si la original de ipod la fuente sano es la mala calidad, la deformación y sonido son advertidos fácilmente con oradores de alto-poder. Trate la sintonía del empujo bajo.
		Cerciórese la tapa final o el telemando no cubren a orador durante el uso.
Telemando no trabaja	las baterías son débiles o muertas.	Instale nuevas pilas.
	el Telemando distancia está demasiado lejos de la unidad principal.	Mueva el telemando a distancia más cerca a la unidad

**NOTA: Cuando el adaptador AC está conectado, su iPod se cargará (con o sin las pilas instaladas).**

**NOTA: La unidad no controla o carga iPod de 3a Generación**

# Limited 90-Day Warranty Information

iHome Products, a division of SDI Technologies Inc. (hereafter referred to as SDI Technologies), warrants this product to be free from defects in workmanship and materials, under normal use and conditions, for a period of 90 days from the date of original purchase.

Should this product fail to function in a satisfactory manner, it is best to first return it to the store where it was originally purchased. Should this fail to resolve the matter and service still be required by reason of any defect or malfunction during the warranty period, SDI Technologies will repair or, at its discretion, replace this product without charge (except for a \$10.00 charge for handling, packing, return UPS/postage, and insurance). This decision is subject to verification of the defect or malfunction upon delivery of this product to the Factory Service Center listed below. The product must include proof of purchase, including date of purchase. The fee for service without proof of purchase is \$30.00.

Before returning this product for service, please first replace the batteries (if applicable) with fresh ones, as exhausted or defective batteries are the most common cause of problems encountered.

If service is still required:

1. Remove the batteries (if applicable) and pack the unit in a well padded, heavy corrugated box.
2. Enclose a photocopy of your sales receipt, credit card statement, or other proof of the date of purchase, if within the warranty period.
3. Enclose a check or money order payable to the order of SDI Technologies, for the sum of \$10.00 (\$30.00 without proof of purchase).
4. Send the unit prepaid and insured, to the Factory Service Center listed below.

## Consumer Repair Department

*SDI Technologies Inc.  
1330 Goodyear Drive  
El Paso, TX 79936-6420*

## Disclaimer of Warranty

**NOTE:** This warranty is valid only if the product is used for the purpose for which it was designed. It does not cover (i) products which have been damaged by negligence or willful actions, misuse or accident, or which have been modified or repaired by unauthorized persons; (ii) cracked or broken cabinets, or units damaged by excessive heat; (iii) damage to digital media players, CD's or tape cassettes (if applicable); (iv) the cost of shipping this product to the Factory Service Center and its return to the owner.

This warranty is valid only in the United States of America and does not extend to owners of the product other than to the original purchaser. In no event will SDI Technologies or any of its affiliates, contractors, resellers, their officers, directors, shareholders, members or agents be liable to you or any third party for any consequential or incidental damages, any lost profits, actual, exemplary or punitive damages. (Some states do not allow limitations on implied warranties or exclusion of consequential damages, so these restrictions may not apply to you.) This warranty gives you specific legal rights, and you may also have other rights which vary from state to state.

Your acknowledgement and agreement to fully and completely abide by the above mentioned disclaimer of warranty is contractually binding to you upon your transfer of currency (money order, cashier's check, or credit card) for purchase of your SDI Technologies product.

© 2007 SDI Technologies, Inc. All rights reserved

**Questions? Visit [www.ihomeaudio.com](http://www.ihomeaudio.com)  
or call 1-800-288-2792 Toll Free**